

Features and Benefits

- Compatible with Viral Kill Model 450 units (sold separately)
- Designed for restaurants and other occupied spaces
- Fits in (2) 2'x2' drop ceiling tiles or (1) 2'x4' drop ceiling tile
- Easy and unobtrusive installation
- Air baffle equipped with sound deadening foam reduces noise to <55dB 3 feet away
- Pulls airborne viruses up and away from personnel
- LED logo panel confirms operation
- One-year limited warranty

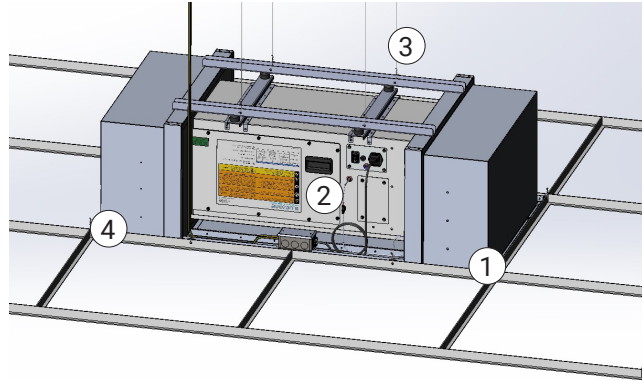

1. Contaminated air inlet
2. Viral Kill Model 450 (sold separately)
3. Wire Hangers
4. Clean air outlet

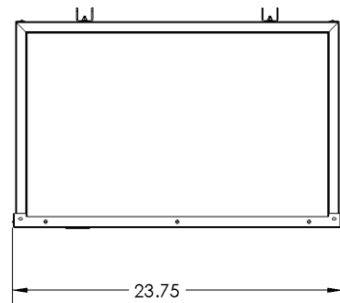
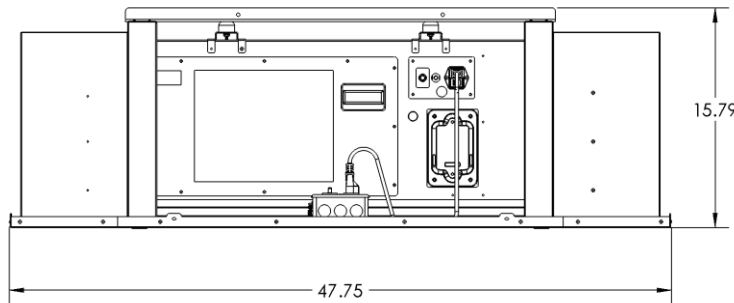

IN-CEILING MOUNT KIT SPECIFICATIONS

Dimensions	47.75" x 23.75" x 15.79" (1530 mm X 521 mm x 806 mm)
Weight	19.53 lb. (108 kg.)
Shipping Dimensions/Weight	52" x 28" x 20" (1321 mm x 711 mm x 508 mm) / 23 lb. (10 kg.)