

**SAEB101**



10 x 1/1 GN

Item

10 - 12 x 20"



**AUTOCLIMA**



**ECOSPEED**



**FAST-DRY**



**GFT**  
(only for gas models)



**ECOVAPOR**



**LCS CLEANING (optional)**  
COMBI CLEAN  
CALFREE (\*)



**2 SPEED FAN (optional)**



**SCS CLEANING (optional)**  
SOLID CLEAN  
SOLID CAL (\*)



**MULTIPOINT CORE PROBE**  
(optional)



**MULTIPROGRAM**  
**KEYBOARD**

(\*) only for models with boiler

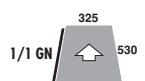

## COOKING MODES

- Automatic with over 90 tested and stored cooking programs including programs for reheating on the plate or in the tray
- Programmable with the ability to store 99 cooking programs in automatic sequence (up to 4 cycles)
- Manual cooking with three cooking modes: Convection from 30°C to 300°C (86°F to 572°F), Steam from 30°C to 130°C (86°F to 266°F), Combination Convection + Steam from 30°C to 300°C (86°F to 572°F).
- Manual with the ability to work with 4 cycles in automatic sequence for differentiated cooking and functions for: Temperature holding (2 modes) - Steam outlet control
- Cooking with core temperature control (with multi-point probe or needle probe) (optional)
- **AUTOCLIMA®** automatic system for measuring and controlling the humidity in the cooking chamber
- **FAST-DRY®** system for quick dehumidification of the cooking chamber
- Multiprogram keypad for quick, "press and go" program selection with nine positions

## OPERATION

- High visibility alphanumeric command display
- Key for managing the 4 cooking cycles with LED display
- Key for direct access to cooking programs that have been stored or are to be stored
- **SCROLLER PLUS** knob with Scroll and Push function for confirming choices
- Manual pre-heating

## CLEANING AND MAINTENANCE

- Self-diagnosis before starting to use the equipment, with descriptive and audible signalling of any anomalies
- Automatic LCS (Liquid Clean System) with COMBICLEAN liquid cleanser and CALFREE liquid descaler, in 100 % recyclable cartridges
- Alternatively: SCS (Solid Clean System) automatic cleaning system with built-in tank and automatic detergent dispensing - **SOLID CLEAN** detergent in 930 g. (2.05 Lbs.) packages used for the generation of detergent
- **CALOUT** descaling system that prevents formation and accumulation of limescale in the boiler, with separate container and automatic dispensing of CALFREE liquid descaling product
- Alternatively: **CALOUT** descaling system that prevents the formation and accumulation of limescale in the boiler, with built-in tank and automatic dispensing - **SOLID CAL** descaler in 850 g. (1.87 Lbs.) packages used for the generation of descaling product
- Manual cleaning system with retractable hand shower

# SAEB101

## CONTROL EQUIPMENT

- Autoreverse (automatic reverse of fan rotation) for perfect cooking uniformity
- Automatically regulated steam condensation
- Manual chamber outlet control
- Manual humidifier
- Halogen lighting
- 2 fan speeds (optional), the reduced speed activates the reduction in heating power
- Temperature control at the product core using probe with 4 detection points
- Core probe connection through a connector outside of the cooking chamber, with the ability to quickly connect the needle probe for vacuum cooking and small pieces (optional)
- USB connection to download HACCP data, update software and load/unload cooking programs
- Ready for SN energy optimization system (optional)
- SERVICE program for inspecting the operation of the electronic board and display of the temperature probes - Appliance operation timer for all primary functions for programmed maintenance
- ECOSPEED - Based on the quantity and type of product, Naboo optimizes and controls the delivery of energy, maintains the correct cooking temperature, preventing any fluctuations (-10% energy / -30% water / -5% weight loss \*)
- ECOVAPOR - With ECOVAPOR system there is a definite reduction in water and energy consumption due to the automatic controls of the steam saturation in the cooking chamber (-10% energy / -30% water / -10% steam \*)

## CONSTRUCTION

- IPX5 protection against sprays of water
- Perfectly smooth, watertight chamber
- Door with double tempered glass with air chamber and interior heat-reflecting glass for less heat radiation towards the operator and greater efficiency
- Internal glass that folds to open for easy cleaning
- Handle with left or right hand opening
- Adjustable hinge for optimal seal
- Deflector that can be opened for easy fan compartment cleaning

## ELECTRIC HEATING SYSTEM

- Cooking compartment heating elements of armoured INCOLOY 800 type

## STEAM GENERATOR

- AISI 304 fully insulated steam generator
- Steam generator heating elements of armoured INCOLOY 800 type
- Automatic boiler pre-heating
- Daily automatic boiler draining; temperature of drained water below 60°C (140°F) and rinsing
- Alarm in case of boiler de-scaling required
- Boiler semi-automatic de-scaling program
- CAL-OUT system to prevent scale build-up within the boiler, as standard

## SAFETY FEATURES

- Cooking compartment safety thermostat
- Cooking compartment safety device for pressure built-up and depression
- Fan motor thermic protection
- Mechanical door switch
- Lack of water displayed alarm
- Self-diagnosis and fault display
- Component cooling system with overheat display control
- Boiler safety thermostat
- Boiler water level probes
- Boiler probe to check boiler completely empty

## STANDARD EQUIPMENT

- CALOUT descaling system (equipped with 1 tank of anti-scale product CALFREE, 4,5 kg. (9.9 Lbs.) each)
- Alternatively: CALOUT descaling system (equipped with 1 can of anti-scale product SOLID CAL - 850 g. (1.87 Lbs.) each)
- Built-in and retractable hand shower with tap
- 2 stainless steel grids 1/1 GN (12x20")
- MULTIPROGRAM Keyboard

## OPTIONAL - TO BE REQUESTED WHEN ORDERING OVEN

- Automatic cleaning system LCS Liquid Clean System (equipped with 2 tanks of COMBICLEAN detergent, 4,5 kg. (9.9 Lbs.) each)
- Alternatively: Automatic cleaning system SCS, Solid Clean System (equipped with 2 cans of SOLID CLEAN - 930 g. (2.05 Lbs.) each)
- Multipoint core probe - Ø 3 mm (Ø 0.12")
- 2 speed fan: normal/reduced
- Extra charge for energy saving system connection
- Opposite hinged door
- Double release door opening
- Extra charge for removable rack + compulsory frame
- Extra charge for pastry version removable rack 600 x 400 + compulsory frame
- Extra charge for pastry version shelf racks 600 x 400

## ACCESSORIES

- Multipoint core probe for large items. Pin length 180 mm (7.08"). Ø 3 mm (Ø 0.12") (only in case it is already fitted with core probe)
- Needle core probe - Ø 1 mm. (Ø 0.04") (only in case it is already fitted with core probe)
- Fat filter
- USB pen to download HACCP data, update software and load/unload cooking programs
- Set of feet, h - 150 mm (5.90")
- Castor kit
- Stainless steel heat shield for the unit right side panel (essential when the oven is positioned next to heat sources)
- Stainless steel floor stand
- Special floor stands for insertion of the blast chiller
- Side runners

\* Compared to our previous model

# SAEB101

- Stainless steel shelf
- Neutral cabinet with doors and side runners
- Neutral cabinet with door
- Flanged feet kit for floor stands, for marine installations
- Castor kit for floor stand, 2 with brake
- Trolley for removable racks with drip tray
- Removable rack (to be used with compulsory frame)
- Compulsory frame for removable oven rack and plate racks
- Pastry version - Removable rack 600 x 400 (to be used with compulsory frame)
- Pastry version - Pair of shelf racks 600 x 400
- Plate racks (to be used with compulsory frame)
- Rack thermal cover

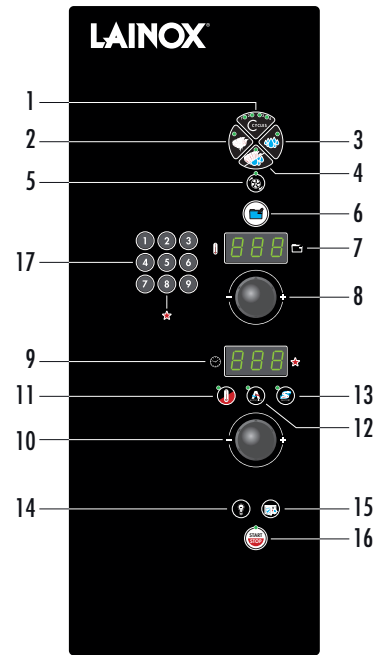

- 1) Cooking cycle button. 2) Convection mode button. 3) Steam mode button. 4) Convection/steam combi mode button. 5) Reduced speed button. 6) Cooking programs button. 7) Display showing cooking chamber temperature and the program/recipe. 8) Temperature setting/selection knob. 9) Display with cooking time (remaining/set), product core temperature display (real/set), humidity display. 10) Knob for setting/Selecting time/Core temperature. 11) Button for cooking with core temperature probe. 12) Button for automatic humidity (AUTOCLIMA), Manual humidifier button. 13) Button for cavity vent. 14) Oven lights key. 15) Button for fast cooling with door open. 16) Main switch - Start/Stop button. 17) MULTIPROGRAM Keyboard

## TECHNICAL DATA

Chamber capacity	GN	10 x 1/1	Total electric power	kW	16
	No. - Inch.	10 - 12 x 20"		Gas versions nominal heating output	kW / kcal
Distance between layers	mm	70			kW / BTU
	Inch	2.76		Chamber heating output	kW / kcal
Number of meals		80 / 150			kW / BTU
	External dimensions	mm		930 x 825 x 1040 h	Steam heating output
Inch		36.62 x 32.48 x 40.95" h	kW / BTU	15 / -	
Dimensions with packing	mm	1040 x 980 x 1250 h	Fan power	kW	1
	Inch	40.94 x 38.58 x 49.21" h		Power supply voltage	V - 60 Hz
Weight - Net / Gross	kg	174 / 197	Consumption		Amps
	Lbs.	383.60 / 434.31			

Special voltages and frequencies upon request

The data reported in this document is to be considered non-binding. Lainox ALI S.p.A reserves the right to make changes at any time, without prior notice.

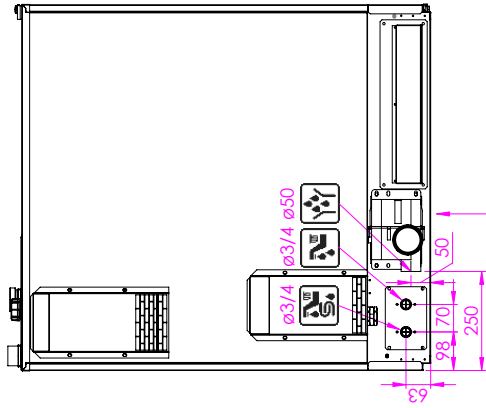
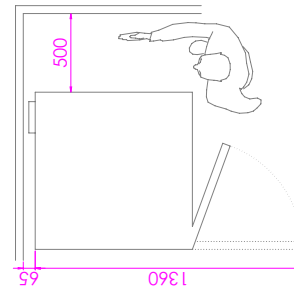
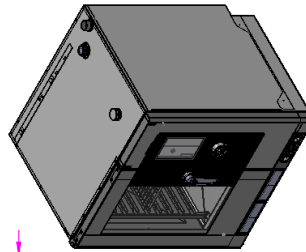
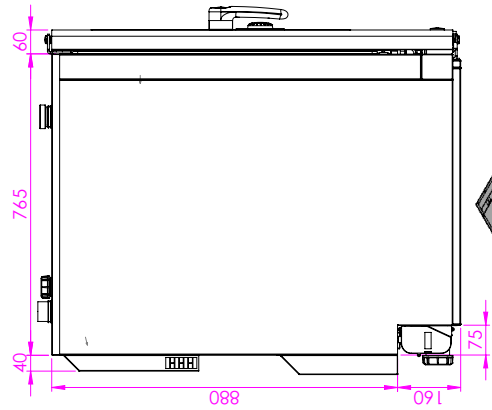
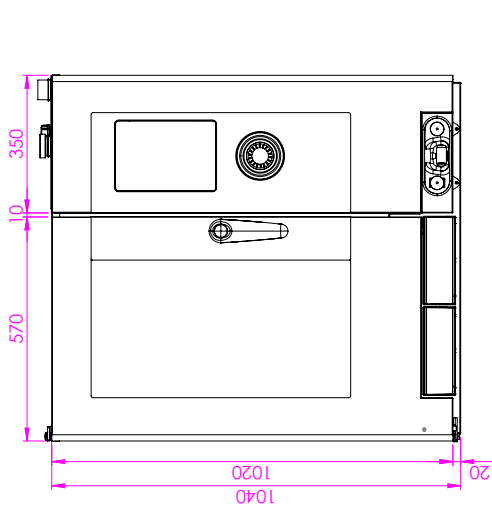

3AC 208V  
3AC 480V

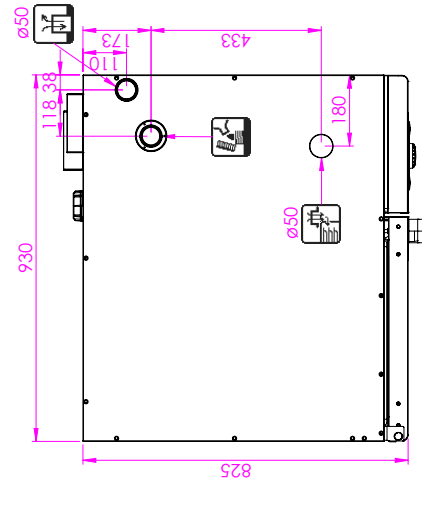
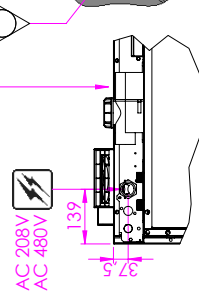

According to CE rules, gas ovens must be installed where proper evacuation of burnt gas can be provided (type B13, B23, A3)

