

Compact by Sapiens

LAINOX[®]
DEVICE FOR COOKING

COMBI STEAMER FOR GASTRONOMY

CVGS061



6 x 1/1 GN

Item

6 - 12 x 20"



AUTOCLIMA



ECOSPEED



FAST-DRY



GFT
(only for gas models)



ECOVAPOR



LCS CLEANING (optional)
COMBI CLEAN
CALFREE (*)



2 SPEED FAN (optional)



**MULTIPROGRAM
KEYBOARD**



MULTIPOINT CORE PROBE
(optional)

(*) only for models with boiler



COOKING MODES

- Automatic with over 90 tested and stored cooking programs including programs for reheating on the plate or in the tray
- Programmable with the ability to store 99 cooking programs in automatic sequence (up to 4 cycles)
- Manual cooking with three cooking modes: convection from 30°C to 300°C (86°F to 572°F), steam from 30°C to 130°C (86°F to 266°F), combination convection + steam from 30°C to 300°C (86°F to 572°F)
- Manual with the ability to work with 4 cycles in automatic sequence for differentiated cooking and functions for: Temperature holding (2 modes) - Steam outlet control
- Cooking with core temperature control (with multi-point probe or needle probe) (optional)
- **AUTOCLIMA**[®] automatic system for measuring and controlling the humidity in the cooking chamber
- **FAST-DRY**[®] system for quick dehumidification of the cooking chamber
- Multiprogram keypad for quick, "press and go" program selection with nine positions

OPERATION

- High visibility alphanumeric command display
- Key for managing the 4 cooking cycles with LED display
- Key for direct access to cooking programs that have been stored or are to be stored
- **SCROLLER PLUS** knob with Scroll and Push function for confirming choices
- Manual pre-heating

CLEANING AND MAINTENANCE

- Self-diagnosis before starting to use the equipment, with descriptive and audible signalling of any anomalies
- Automatic LCS (Liquid Clean System) with COMBICLEAN liquid cleanser, in 100 % recyclable cartridges
- Manual cleaning system with external hand shower (optional)

CONTROL EQUIPMENT

- Autoreverse (automatic reverse of fan rotation) for perfect cooking uniformity
- Automatically regulated steam condensation
- Manual chamber outlet control
- Manual humidifier
- Halogen lighting
- 2 fan speeds (optional), the reduced speed activates the reduction in heating power

CVGS061

- Temperature control at the product core using probe with 4 detection points
- Core probe connection through a connector outside of the cooking chamber, with the ability to quickly connect the needle probe for vacuum cooking and small pieces (optional)
- USB connection to download HACCP data, update software and load/unload cooking programs
- SERVICE program for inspecting the operation of the electronic board and display of the temperature probes - Appliance operation timer for all primary functions for programmed maintenance
- **ECOSPEED** - Based on the quantity and type of product, the oven optimizes and controls the delivery of energy, maintains the correct cooking temperature, preventing any fluctuations (-10% energy / -30% water / -5% weight loss *)
- **ECOVAPOR** - With ECOVAPOR system there is a definite reduction in water and energy consumption due to the automatic controls of the steam saturation in the cooking chamber (-10% energy / -30% water / -10% steam *)
- **GREEN FINE TUNING** - A new burner modulation system and high efficiency exchanger to prevent power waste and reduce harmful emissions (-10% energy / -10% CO2 *)

CONSTRUCTION

- IPX5 protection against sprays of water
- Perfectly smooth, watertight chamber
- Door with double tempered glass with air chamber and interior heat-reflecting glass for less heat radiation towards the operator and greater efficiency
- Internal glass that folds to open for easy cleaning
- Handle with left or right hand opening
- Adjustable hinge for optimal seal
- Deflector that can be opened for easy fan compartment cleaning

GAS HEATING SYSTEM

- Blown air type of modulating burners for the cavity
- Automatic flame ignition
- Electronic control of the flame with automatic ignition reset
- High efficiency heat exchanger with steel AISI 310 S expansion cabinet

SAFETY FEATURES

- Cooking compartment safety thermostat
- Cooking compartment safety device for pressure built-up and depression
- Fan motor thermic protection
- Flame detection sensor interrupting gas flow in case of switch of flame failure
- Safety pressure switch for lack of gas alarm
- Magnetic door switch
- Lack of water displayed alarm
- Self-diagnosis and fault display
- Component cooling system with overheat display control
- Two-stage gas valve

STANDARD EQUIPMENT

- 2 stainless steel grids 1/1 GN (12x20")
- MULTIPROGRAM Keyboard

OPTIONAL - TO BE REQUESTED WHEN ORDERING OVEN

- Automatic cleaning system LCS Liquid Clean System - equipped with 1 tank of COMBICLEAN detergent, 4,5 kg. (9.9 Lbs.)
- Multipoint core probe - Ø 3 mm. (Ø 0.12")
- 2 speed fan: normal/reduced
- Opposite hinged door

ACCESSORIES

- Needle core probe - ø 1 mm. (Ø 0.04") - (only in case it is already fitted with core probe)
- Wash shower with fittings and attachments
- Fat filter
- Set of feet h - 150 mm (5.90")
- Stainless steel heat shield for the unit right side panel (essential when the oven is positioned next to heat sources)
- Stainless steel floor stand
- Special floor stands for insertion of the blast chiller
- Side runners
- Neutral cabinet with doors and side runners
- Neutral cabinet with door
- Stainless steel shelf
- Flanged feet kit for floor stands, for marine installations
- Castor kit for floor stand, 2 with brake
- Installation frame for Hood h - 150 mm (5.90")
- Marine Version Kit. Flanged feet - Door immobilizing lock - Special rack rails

* Compared to our previous model

CVGS061

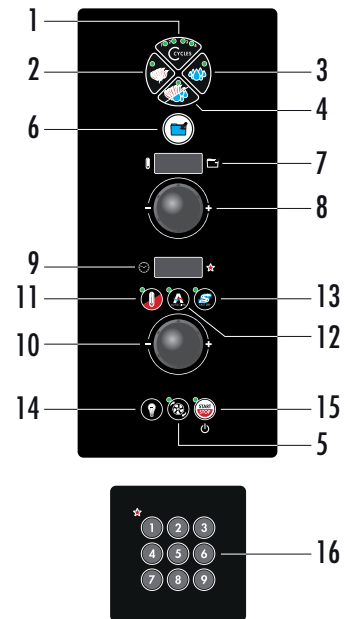

- 1) Cooking cycle button. 2) Convection mode button. 3) Steam mode button. 4) Convection/steam combi mode button. 5) Reduced speed button. 6) Cooking programs button. 7) Display showing cooking chamber temperature and the program/recipe. 8) Temperature setting/selection knob. 9) Display with cooking time (remaining/set), product core temperature display (real/set), humidity display. 10) Knob for setting/Selecting time/Core temperature. 11) Button for cooking with core temperature probe. 12) Button for automatic humidity (AUTOCLIMA), Manual humidifier button. 13) Button for cavity vent. 14) Oven lights key. 15) Main switch - Start/Stop button. 16) MULTIPROGRAM Keyboard.

TECHNICAL DATA

Chamber capacity	GN	6 x 1/1	Total electric power	kW	0,25
	No. - Inch.	6 - 12 x 20"		Gas versions nominal heating output	kW / kcal
Distance between layers	mm	60			kW / BTU
	Inch	2.36		Chamber heating output	kW / kcal
Number of meals		30 / 80			kW / BTU
	External dimensions	mm		875 x 650 x 705 h	Steam heating output
Inch		34.45 x 25.59 x 27.76" h	Fan power	kW / BTU	
Dimensions with packing	mm	900 x 765 x 810 h			kW
	Inch	35.43 x 30.12 x 31.89" h	Power supply voltage		V - 60 Hz
Weight - Net / Gross	kg	92 / 105		Consumption	Amps
	Lbs.	202.82 / 231.48			

Special voltages and frequencies upon request

CVGS061

(mm)

The data reported in this document is to be considered non-binding. Lainox ALI S.p.A reserves the right to make changes at any time, without prior notice



Electric power supply cable inlet



Gas inlet and type of thread



Flue pipe



Boiler descaling cap

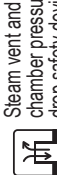

Steam vent and chamber pressure drop safety device



Oven steam vent



Air extraction



Normal water inlet



Softened water inlet



Liquid outlet



Steam trap

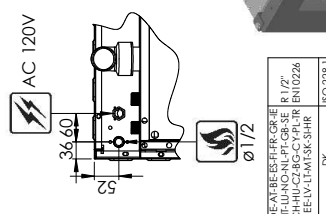
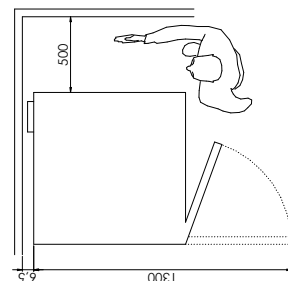
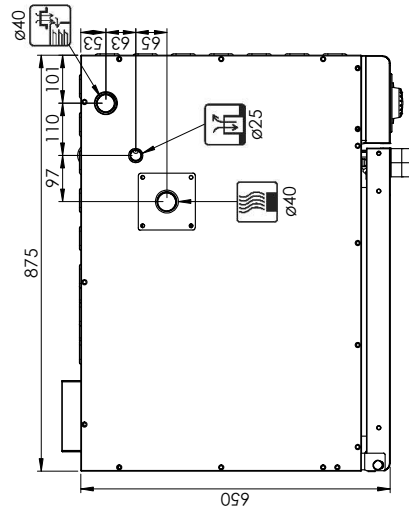
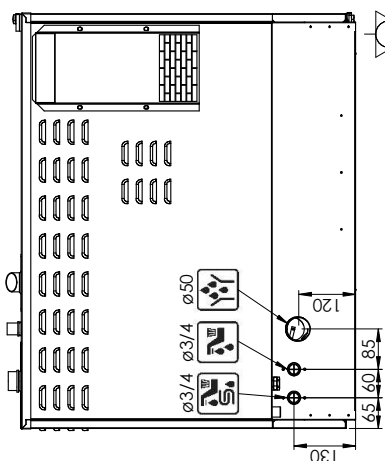
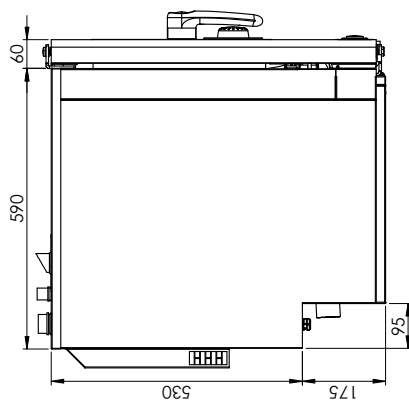
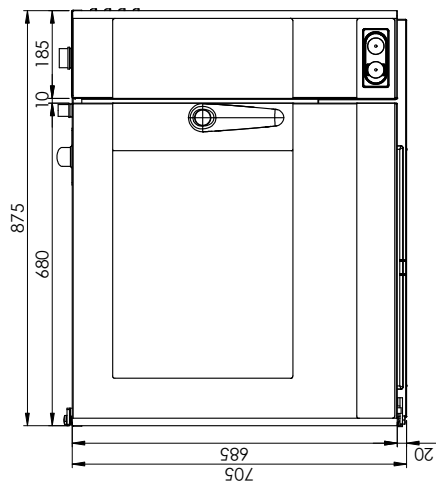



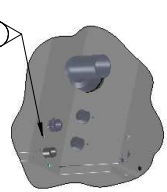
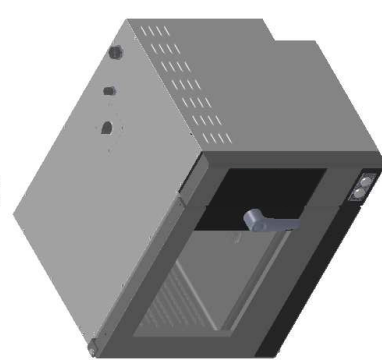







DESIGN CERTIFICATION R 1/27
DE (AI) NO. 010175/00018
CH-HU-CZ-CC-V-PL-TR EN10226
EE-LV-LT-MT-SK-SHR
DK ISO 2281



According to CE rules, gas ovens must be installed where proper evacuation of burnt gas can be provided. (type B 13, B23, A3)



The data reported in this document is to be considered non-binding. Lainox ALI S.p.A reserves the right to make changes at any time, without prior notice

-  Electric power supply cable inlet
-  Gas inlet and type of thread
-  Flue pipe
-  Boiler descaling cap
-  Steam vent and chamber pressure drop safety device
-  Oven steam vent
-  Air extraction
-  Normal water inlet
-  Softened water inlet
-  Liquid outlet
-  Steam trap

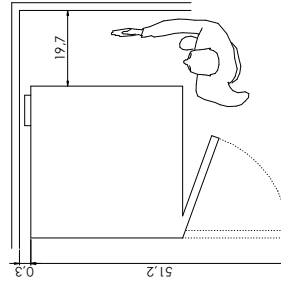
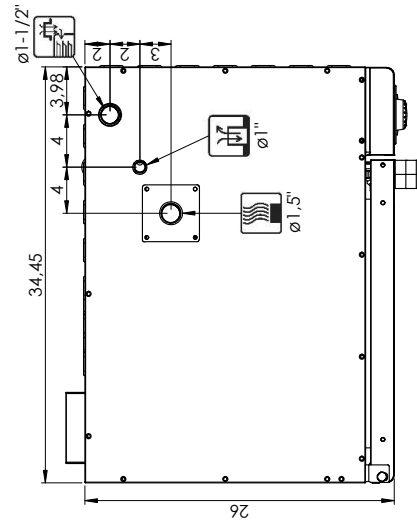
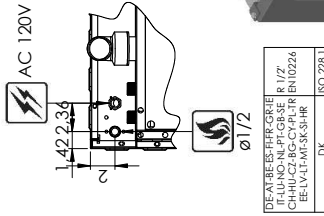
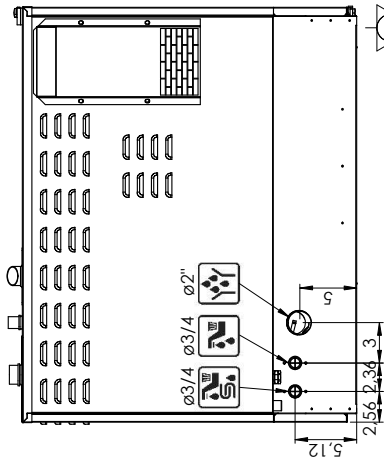
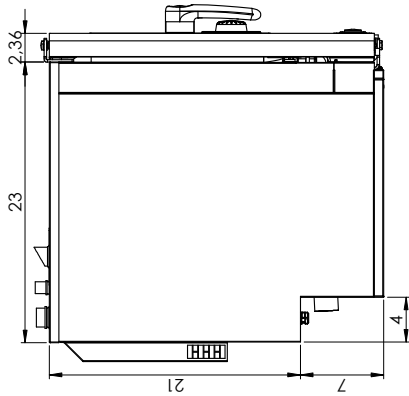
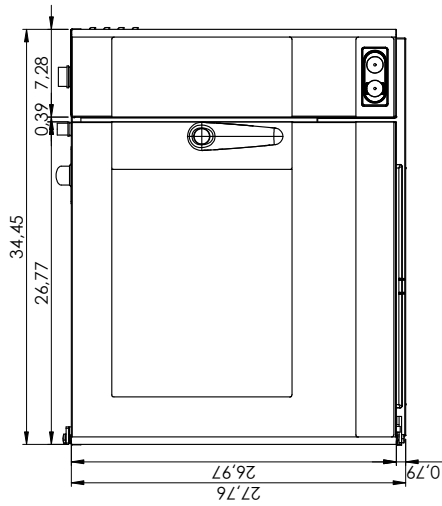

According to CE rules, gas ovens must be installed where proper evacuation of burnt gas can be provided (type B13, B23, A3)