

NAGB101



10 x 1/1 GN

Item

10 - 12 x 20"



LCD 10" Touch Screen

One Touch

Automatically and with only a single touch, you can access the ideal and most efficient cooking for each dish, due to the exclusive present and widely tested methods, times and system. A wide range of cooking methods is already tested in the field by a highly qualified group of workers.



MULTILEVEL



ECOSPEED



JUST IN TIME



GFT
(only for gas models)



AUTOCLIMA



LCS CLEANING SYSTEM
COMBI CLEAN
CALFREE (*)



FAST-DRY



SCS CLEANING SYSTEM
SOLID CLEAN
SOLID CAL (*)



SMOKING



CLOUD EVOLUTION



FLAVOURING



CHEF PORTAL



ECOVAPOR



SYNCHRONISATION



TURBOVAPOR (*)



REMOTE SERVICE



VIDEO RECIPES

(*) only for models with boiler

COOKING MODES

- ICS (Interactive Cooking System), an automatic cooking system for Italian, French, International, Spanish, Russian, Asian and German recipes including their history, ingredients, procedure, automatic cooking program and plate presentation
- Manual cooking with three cooking modes: Convection from 30°C to 300°C (86°F to 572°F), Steam from 30°C to 130°C (86°F to 266°F), Combination Convection + Steam from 30°C to 300°C (86°F to 572°F).
- Programmable modes - Possibility to program and save cooking methods in an automatic sequence (up to 15 cycles) giving each program its own name, picture and information on the recipe

OPERATION

- DISPLAY that can be configured based on the needs of the user, bringing forward the programs used most
- LAINOX Cloud Wi-Fi/Ethernet connection system for saving personal settings, software updates, HACCP data archiving and downloading new recipes
- Automatic "one touch" cooking (ICS)
- Organization of recipes in folders with preview, giving each folder its own name
- Intelligent recognition of recipes in multilevel folders
- 10" colour screen (LCD - TFT) that is high definition and capacitive with "Touch Screen" functions
- SCROLLER PLUS knob with Scroll and Push function for confirming choices
- Automatic door opening using the "Open" button (optional)
- Instantaneous display in ICS cooking of the HACCP graphic

CLEANING AND MAINTENANCE

- Self-diagnosis before starting to use the equipment, with descriptive and audible signalling of any anomalies
- Automatic LCS (Liquid Clean System) with COMBICLEAN liquid cleanser and CALFREE liquid descaler, in 100 % recyclable cartridges
- Alternatively: SCS (Solid Clean System) automatic cleaning system with built-in tank and automatic detergent dispensing - SOLID CLEAN detergent in 930 g. (2.05 Lbs.) packages used for the generation of detergent
- CALOUT descaling system that prevents formation and accumulation of limescale in the boiler, with separate container and automatic dispensing of CALFREE liquid descaling product
- Alternatively: CALOUT descaling system that prevents the formation and accumulation of limescale in the boiler, with built-in tank and automatic dispensing - SOLID CAL descaler in 850 g. (1.87 Lbs.) packages used for the generation of descaling product
- Manual cleaning system with retractable hand shower

CONTROL EQUIPMENT

- Autoreverse (automatic reverse of fan rotation) for perfect cooking uniformity
- Automatic parallel compartment and core temperature control, DELTA T system
- Automatically regulated steam condensation
- Programmable deferred cooking
- Ability to choose up to 6 fan speeds; the first 3 speeds automatically activate the reduction in heating power
- For special cooking methods, you can use an intermittent speed
- Temperature control at the product core using probe with 4 detection points
- 2 core probe, a LAINOX exclusive
- Core probe connection through a connector outside of the cooking chamber, with the ability to quickly connect the needle probe for vacuum cooking and small pieces
- USB connection to download HACCP data, update software and load/unload cooking programs
- SERVICE program for: Inspecting the operation of the electronic board and display of the temperature probes - Appliance operation timer for all primary functions for programmed maintenance
- ECOSPEED - Based on the quantity and type of product, Naboo optimizes and controls the delivery of energy, maintains the correct cooking temperature, preventing any fluctuations (-10% energy / -30% water / -5% weight loss *)
- ECOVAPOR - With ECOVAPOR system there is a definite reduction in water and energy consumption due to the automatic controls of the steam saturation in the cooking chamber (-10% energy / -30% water / -10% steam *)
- TURBOVAPOR - With the TurboVapor system it automatically produces the ideal level of steam to cook "tough" products like egg pasta or asparagus, turnip greens and chard, which are notoriously fibrous vegetables
- GREEN FINE TUNING - A new burner modulation system and high efficiency exchanger to prevent power waste and reduce harmful emissions (-10% energy / -10% CO2 *)

CONSTRUCTION

- IPX5 protection against sprays of water
- Perfectly smooth, watertight chamber
- Door with double tempered glass with air chamber and interior heat-reflecting glass for less heat radiation towards the operator and greater efficiency
- Internal glass that folds to open for easy cleaning
- Handle with left or right hand opening
- Adjustable hinge for optimal seal
- Deflector that can be opened for easy fan compartment cleaning

GAS HEATING SYSTEM

- Blown air type of modulating burners for the cavity
- Automatic flame ignition
- Electronic control of the flame with automatic ignition reset
- High efficiency heat exchanger with steel AISI 310 S expansion cabinet

STEAM GENERATOR

- AISI 316 fully insulated steam generator
- Blown air type of modulating burners for the steam generator
- Automatic boiler pre-heating
- Daily automatic boiler draining; temperature of drained water below 60°C (140°F) and rinsing
- Alarm in case of boiler de-scaling required
- Boiler semi-automatic de-scaling program
- CAL-OUT system to prevent scale build-up within the boiler, as standard

SAFETY FEATURES

- Cooking compartment safety thermostat
- Cooking compartment safety device for pressure built-up and depression
- Fan motor thermic protection
- Flame detection sensor interrupting gas flow in case of switch of flame failure
- Safety pressure switch for lack of gas alarm
- Magnetic door switch
- Lack of water displayed alarm
- Self-diagnosis and fault display
- Component cooling system with overheat display control
- Two-stage gas valve
- Boiler safety thermostat
- Boiler water level probes
- Boiler probe to check boiler completely empty

STANDARD EQUIPMENT

- Automatic cleaning system LCS Liquid Clean System - equipped with 2 tanks of COMBICLEAN detergent, 4,5 kg. (9.9 Lbs.) each
- Alternatively: Automatic cleaning system SCS, Solid Clean System - equipped with 2 cans of SOLID CLEAN - 930 g. (2.05 Lbs.) each
- CALOUT descaling system - equipped with 1 tank of anti-scale product CALFREE, 4,5 kg. (9.9 Lbs.) each
- Alternatively: CALOUT descaling system - equipped with 1 can of anti-scale product SOLID CAL - 850 g. (1.87 Lbs.) each
- Wi-Fi connection

NAGB101

- Multipoint core probe - Ø 3 mm (Ø 0.12")
- Built-in and retractable hand shower with tap
- 2 stainless steel grids 1/1 GN (12x20")

OPTIONAL - TO BE REQUESTED WHEN ORDERING OVEN

- Automatic door opening - not compatible with handle (not available with right hinged door)
- Opposite hinged door
- Double release door opening
- Flue with wind protection device (compulsory for all installations without extraction hood)
- Extra charge for removable rack + compulsory frame
- Extra charge for pastry version removable rack 600 x 400 + compulsory frame
- Extra charge for pastry version shelf racks 600 x 400
- SMOKEGRILL - 3 in 1 - Barbecue System / Smoking / Flavouring
- Extra charge for Ethernet connection

ACCESSORIES











- Multipoint core probe for large items. Pin length 180 mm. (7.08") - Ø 3 mm (Ø 0.12")
- Needle core probe - Ø 1 mm. (Ø 0.04")
- Multiprobes system - 2 multipoint core probes - Ø 3 mm. (Ø 0.12")
- Fat filter
- USB pen to download HACCP data, update software and load/unload cooking programs
- Set of feet, h - 150 mm (5.90")
- Stainless steel heat shield for the unit right side panel (essential when the oven is positioned next to heat sources)
- Stainless steel floor stand
- Special floor stands for insertion of the blast chiller
- Side runners
- Stainless steel shelf
- Neutral cabinet with doors and side runners
- Neutral cabinet with door
- Flanged feet kit for floor stands, for marine installations
- Castor kit for floor stand, 2 with brake
- Trolley for removable oven racks with drip tray
- Removable rack (to be used with compulsory frame)
- Compulsory frame for removable oven rack and plate racks
- Pastry version - Removable rack 600 x 400 (to be used with compulsory frame)
- Pastry version - Pair of shelf racks 600 x 400
- Plate racks (to be used with compulsory frame)
- Rack thermal cover

TECHNICAL DATA

Chamber capacity	GN	10 x 1/1	Total electric power	kW	1
	No. - Inch.	10 - 12 x 20"			
Distance between layers	mm	70	Gas versions nominal heating output	kW / kcal	28 / 24080
	Inch	2.76		kW / BTU	28 / 95,539
Number of meals		80 / 150	Chamber heating output	kW / kcal	18 / 15480
				kW / BTU	18 / 61,418
External dimensions	mm	930 x 825 x 1040 h	Steam heating output	kW / kcal	18 / 15480
	Inch	36.62 x 32.48 x 40.95" h		kW / BTU	18 / 61,418
Dimensions with packing	mm	1040 x 980 x 1250 h	Fan power	kW	1
	Inch	40.94 x 38.58 x 49.21" h			
Weight - Net / Gross	kg	186 / 208	Power supply voltage	V - 60 Hz	1ph / 120
	Lbs.	410.05 / 458.56			
			Consumption	Amps	10

Special voltages and frequencies upon request

The data reported in this document is to be considered non-binding. Lainox ALI S.p.A reserves the right to make changes at any time, without prior notice

-  Electric power supply cable inlet
-  Gas inlet and type of thread
-  Flue pipe
-  Boiler descaling cap
-  Steam vent and chamber pressure drop safety device
-  Oven steam vent
-  Air extraction
-  Normal water inlet
-  Softened water inlet
-  Liquid outlet
-  Steam trap

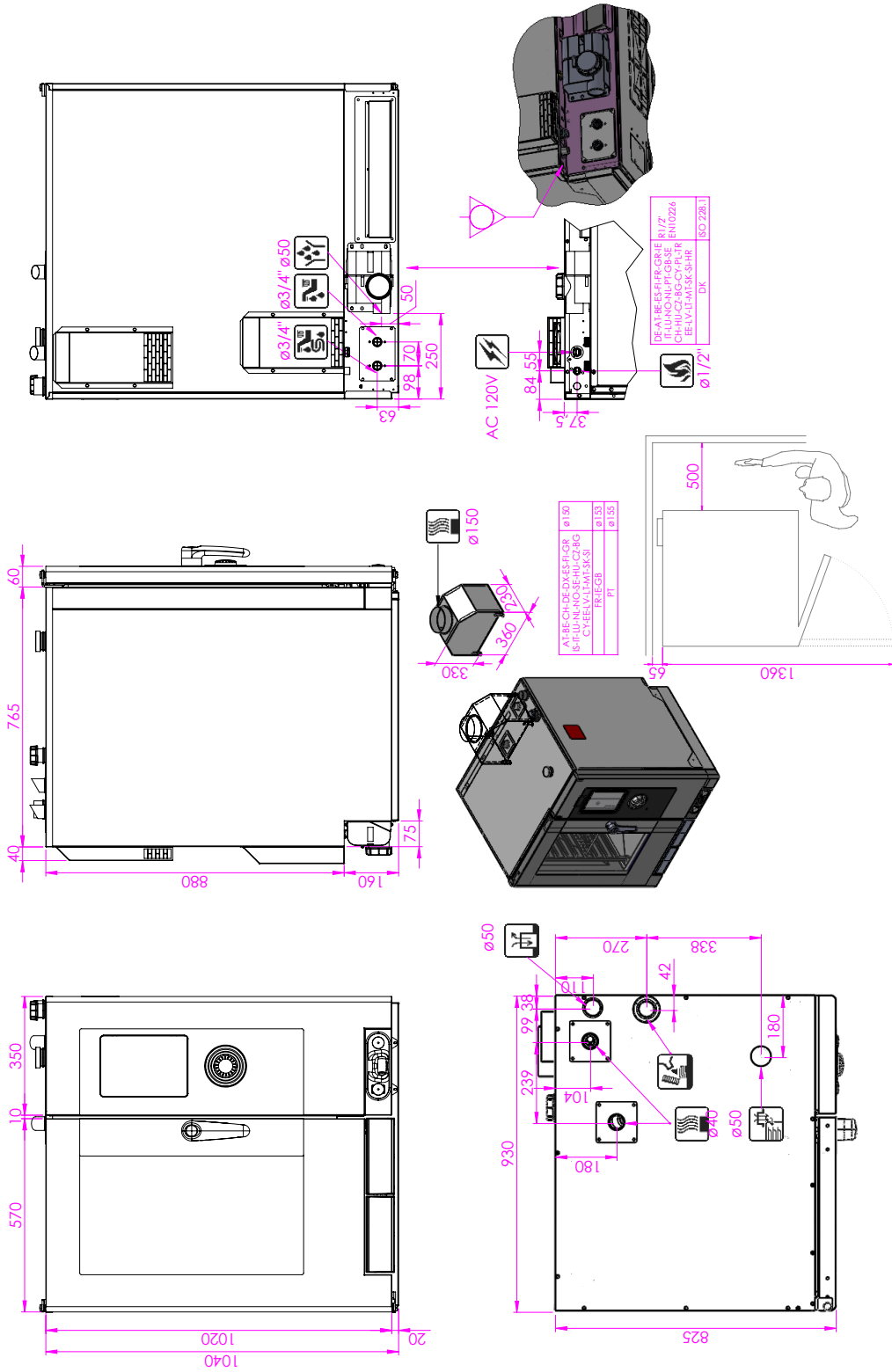

According to CE rules, gas ovens must be installed where proper evacuation of burnt gas can be provided (type B13, B23, A3)



-  Electric power supply cable inlet
-  Gas inlet and type of thread
-  Flue pipe
-  Boiler descaling cap
-  Steam vent and chamber pressure drop safety device
-  Oven steam vent
-  Air extraction
-  Normal water inlet
-  Softened water inlet
-  Liquid outlet
-  Steam trap

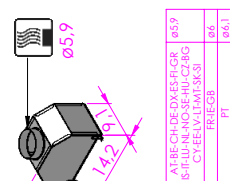
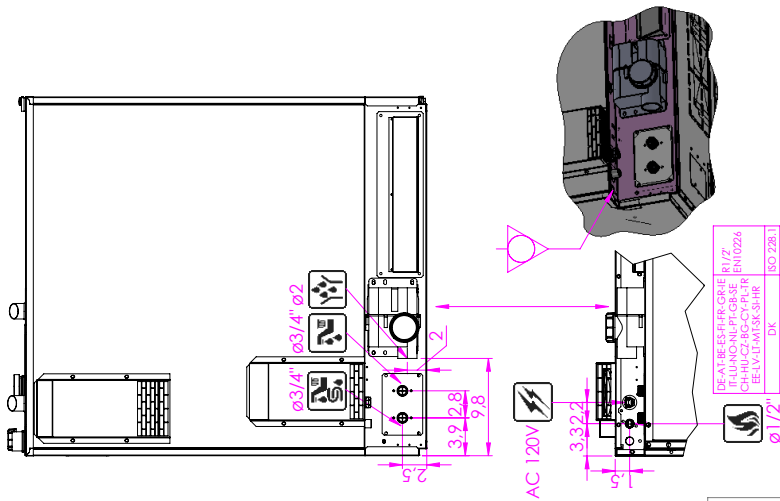
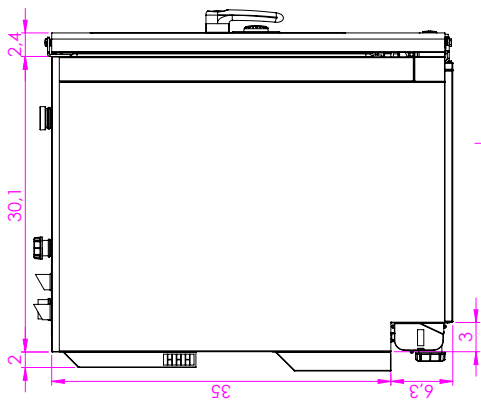
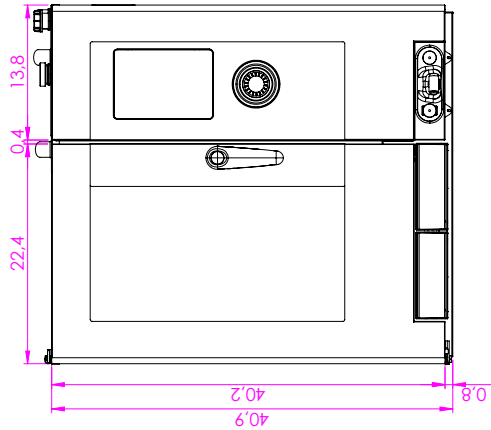

Model	Part No.
AT-RECH-DE-DES-FILGR	059
BR-ILU-NO-RE-HU-CZ-RIG	064
CI-EELU-LAM-SK31	061
FC-GR	061
PT	061

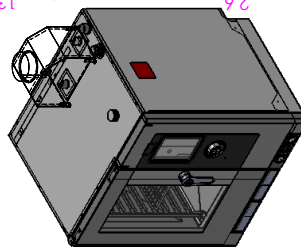

Model	Part No.
BE-ALU-ES-ER-SHRE	R1/2
CH-ALU-ES-ER-SHRE	R1/2
CH-HU-CZ-RC-CY-PLTR	R1/2
BE-LV-EM-MSK-SHRE	R1/2
DK	R1/2
NO 2283	

AC 120V



Ø 3/4" Ø2

Ø 1/2"

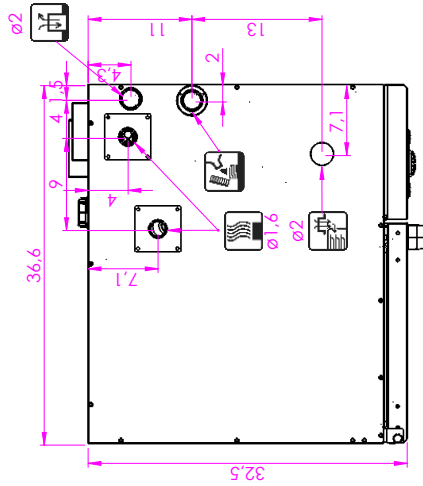

According to CE rules, gas ovens must be installed where proper evacuation of burnt gas can be provided (type B13, B23, A3)