

## NAGV101



10 x 1/1 GN

Item

10 - 12 x 20"



LCD 10" Touch Screen

### One Touch

Automatically and with only a single touch, you can access the ideal and most efficient cooking for each dish, due to the exclusive present and widely tested methods, times and system. A wide range of cooking methods is already tested in the field by a highly qualified group of workers.



MULTILEVEL



ECOSPEED



JUST IN TIME



GFT  
(only for gas models)



AUTOCLIMA



LCS CLEANING SYSTEM  
COMBI CLEAN  
CALFREE (\*)



FAST-DRY



SCS CLEANING SYSTEM  
SOLID CLEAN  
SOLID CAL (\*)



SMOKING



CLOUD EVOLUTION



FLAVOURING



CHEF PORTAL



ECOVAPOR



SYNCHRONISATION



TURBOVAPOR (\*)



REMOTE SERVICE



VIDEO RECIPES

(\*) only for models with boiler

### COOKING MODES

- ICS (Interactive Cooking System), an automatic cooking system for Italian, French, International, Spanish, Russian, Asian and German recipes including their history, ingredients, procedure, automatic cooking program and plate presentation
- Manual cooking with three cooking modes: Convection from 30°C to 300°C (86°F to 572°F), Steam from 30°C to 130°C (86°F to 266°F), Combination Convection + Steam from 30°C to 300°C (86°F to 572°F).
- Programmable modes - Possibility to program and save cooking methods in an automatic sequence (up to 15 cycles) giving each program its own name, picture and information on the recipe

### OPERATION

- DISPLAY that can be configured based on the needs of the user, bringing forward the programs used most
- LAINOX Cloud Wi-Fi/Ethernet connection system for saving personal settings, software updates, HACCP data archiving and downloading new recipes
- Automatic "one touch" cooking (ICS)
- Organization of recipes in folders with preview, giving each folder its own name
- Intelligent recognition of recipes in multilevel folders
- 10" colour screen (LCD - TFT) that is high definition and capacitive with "Touch Screen" functions
- SCROLLER PLUS knob with Scroll and Push function for confirming choices
- Automatic door opening using the "Open" button (optional)
- Instantaneous display in ICS cooking of the HACCP graphic

# NAGV101

## CLEANING AND MAINTENANCE

- Self-diagnosis before starting to use the equipment, with descriptive and audible signalling of any anomalies
- Automatic LCS (Liquid Clean System) with COMBICLEAN liquid cleanser, in 100 % recyclable cartridges
- Alternatively: SCS (Solid Clean System) automatic cleaning system with built-in tank and automatic detergent dispensing - SOLID CLEAN detergent in 930 g. (2.05 Lbs.) packages used for the generation of detergent
- Manual cleaning system with retractable hand shower

## CONTROL EQUIPMENT

- Autoreverse (automatic reverse of fan rotation) for perfect cooking uniformity
- Automatic parallel compartment and core temperature control, DELTA T system
- Automatically regulated steam condensation
- Programmable deferred cooking
- Ability to choose up to 6 fan speeds; the first 3 speeds automatically activate the reduction in heating power
- For special cooking methods, you can use an intermittent speed
- Temperature control at the product core using probe with 4 detection points
- 2 core probe, a LAINOX exclusive
- Core probe connection through a connector outside of the cooking chamber, with the ability to quickly connect the needle probe for vacuum cooking and small pieces
- USB connection to download HACCP data, update software and load/unload cooking programs
- SERVICE program for: Inspecting the operation of the electronic board and display of the temperature probes - Appliance operation timer for all primary functions for programmed maintenance
- ECOSPEED - Based on the quantity and type of product, Naboo optimizes and controls the delivery of energy, maintains the correct cooking temperature, preventing any fluctuations (-10% energy / -30% water / -5% weight loss \*)
- ECOVAPOR - With ECOVAPOR system there is a definite reduction in water and energy consumption due to the automatic controls of the steam saturation in the cooking chamber (-10% energy / -30% water / -10% steam \*)
- GREEN FINE TUNING - A new burner modulation system and high efficiency exchanger to prevent power waste and reduce harmful emissions (-10% energy / -10% CO2 \*)

## CONSTRUCTION

- IPX5 protection against sprays of water
- Perfectly smooth, watertight chamber
- Door with double tempered glass with air chamber and interior heat-reflecting glass for less heat radiation towards the operator and greater efficiency
- Internal glass that folds to open for easy cleaning
- Handle with left or right hand opening
- Adjustable hinge for optimal seal
- Deflector that can be opened for easy fan compartment cleaning

## GAS HEATING SYSTEM

- Blown air type of modulating burners for the cavity
- Automatic flame ignition
- Electronic control of the flame with automatic ignition reset
- High efficiency heat exchanger with steel AISI 310 S expansion cabinet

## SAFETY FEATURES

- Cooking compartment safety thermostat
- Cooking compartment safety device for pressure built-up and depression
- Fan motor thermic protection
- Flame detection sensor interrupting gas flow in case of switch of flame failure
- Safety pressure switch for lack of gas alarm
- Magnetic door switch
- Lack of water displayed alarm
- Self-diagnosis and fault display
- Component cooling system with overheat display control
- Two-stage gas valve

## STANDARD EQUIPMENT

- Automatic cleaning system LCS Liquid Clean System - equipped with 2 tanks of COMBICLEAN detergent, 4,5 kg. (9.9 Lbs.) each
- Alternatively: Automatic cleaning system SCS, Solid Clean System - equipped with 2 cans of SOLID CLEAN - 930 g. (2.05 Lbs.) each
- Wi-Fi connection
- Multipoint core probe - Ø 3 mm (Ø 0.12")
- Built-in and retractable hand shower with tap
- 2 stainless steel grids 1/1 GN (12x20")

## OPTIONAL - TO BE REQUESTED WHEN ORDERING OVEN

- Automatic door opening - not compatible with handle (not available with right hinged door)
- Opposite hinged door
- Double release door opening
- Flue with wind protection device (compulsory for all installations without extraction hood)
- Extra charge for removable rack + compulsory frame
- Extra charge for pastry version removable rack 600 x 400 + compulsory frame
- Extra charge for pastry version shelf racks 600 x 400
- SMOKEGRILL - 3 in 1 - Barbecue System / Smoking / Flavouring
- Extra charge for Ethernet connection

## ACCESSORIES

- Multipoint core probe for large items. Pin length 180 mm. (7.08") - Ø 3 mm (Ø 0.12")
- Needle core probe - Ø 1 mm. (Ø 0.04")
- Multiprobes system - 2 multipoint core probes - Ø 3 mm. (Ø 0.12")
- Fat filter
- USB pen to download HACCP data, update software and load/unload cooking programs
- Set of feet, h - 150 mm (5.90")

\* Compared to our previous model

# NAGV101











- Stainless steel heat shield for the unit right side panel (essential when the oven is positioned next to heat sources)
- Stainless steel floor stand
- Special floor stands for insertion of the blast chiller
- Side runners
- Stainless steel shelf
- Neutral cabinet with doors and side runners
- Neutral cabinet with door
- Flanged feet kit for floor stands, for marine installations
- Castor kit for floor stand, 2 with brake
- Trolley for removable oven racks with drip tray
- Removable rack (to be used with compulsory frame)
- Compulsory frame for removable oven rack and plate racks
- Pastry version - Removable rack 600 x 400 (to be used with compulsory frame)
- Pastry version - Pair of shelf racks 600 x 400
- Plate racks (to be used with compulsory frame)
- Rack thermal cover

## TECHNICAL DATA

|                         |             |                          |                                     |           |             |
|-------------------------|-------------|--------------------------|-------------------------------------|-----------|-------------|
| Chamber capacity        | GN          | 10 x 1/1                 | Total electric power                | kW        | 1           |
|                         | No. - Inch. | 10 - 12 x 20"            |                                     |           |             |
| Distance between layers | mm          | 70                       | Gas versions nominal heating output | kW / kcal | 18 / 15480  |
|                         | Inch        | 2.76                     |                                     | kW / BTU  | 18 / 61,418 |
| Number of meals         |             | 80 / 150                 | Chamber heating output              | kW / kcal | 18 / 15480  |
|                         |             |                          |                                     | kW / BTU  | 18 / 61,418 |
| External dimensions     | mm          | 930 x 825 x 1040 h       | Steam heating output                | kW / kcal | - / -       |
|                         | Inch        | 36.62 x 32.48 x 40.95" h |                                     | kW / BTU  | - / -       |
| Dimensions with packing | mm          | 1040 x 980 x 1250 h      | Fan power                           | kW        | 1           |
|                         | Inch        | 40.94 x 38.58 x 49.21" h |                                     |           |             |
| Weight - Net / Gross    | kg          | 180 / 205                | Power supply voltage                | V - 60 Hz | 1ph / 120   |
|                         | Lbs.        | 396.83 / 451.94          |                                     |           |             |
|                         |             |                          | Consumption                         | Amps      | 10          |

Special voltages and frequencies upon request

The data reported in this document is to be considered non-binding. Lainox ALI S.p.A reserves the right to make changes at any time, without prior notice

-  Electric power supply cable inlet
-  Gas inlet and type of thread
-  Flue pipe
-  Boiler descaling cap
-  Steam vent and chamber pressure drop safety device
-  Oven steam vent
-  Air extraction
-  Normal water inlet
-  Softened water inlet
-  Liquid outlet
-  Steam trap

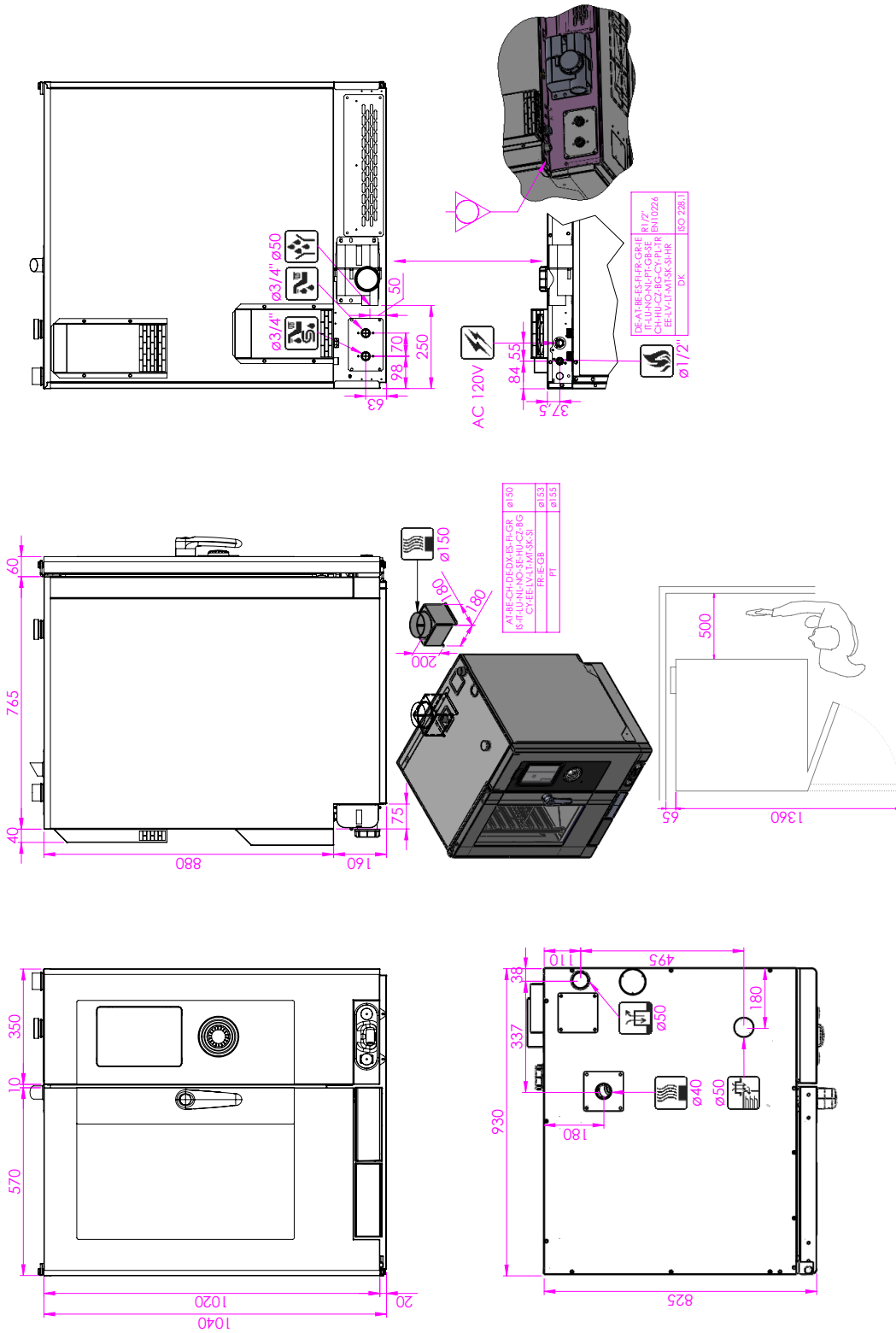

According to CE rules, gas ovens must be installed where proper evacuation of burnt gas can be provided (type B13, B23, A3)



The data reported in this document is to be considered non-binding. Lainox ALI S.p.A reserves the right to make changes at any time, without prior notice

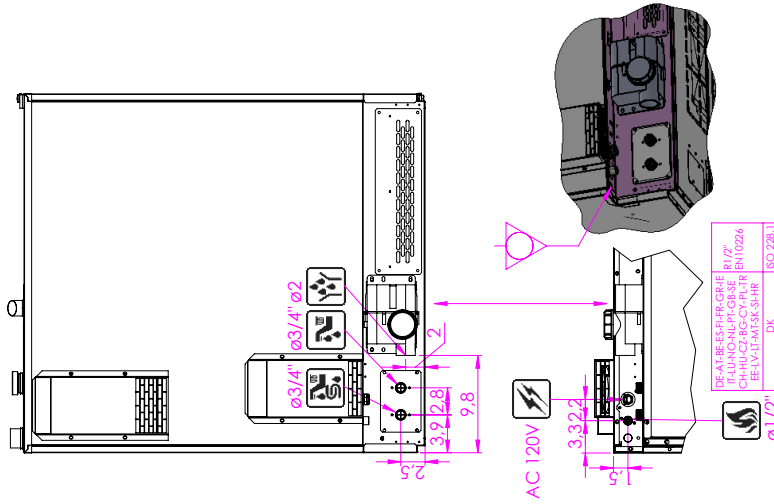
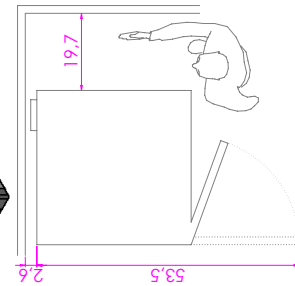
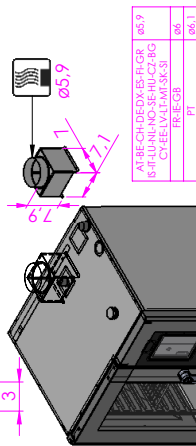
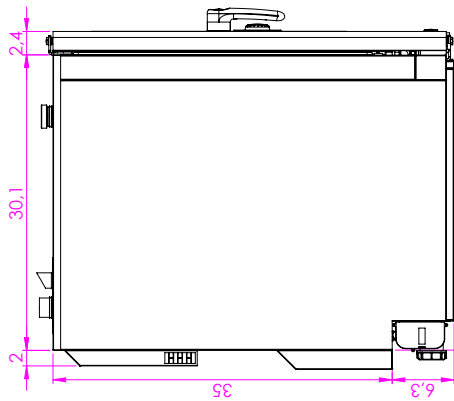
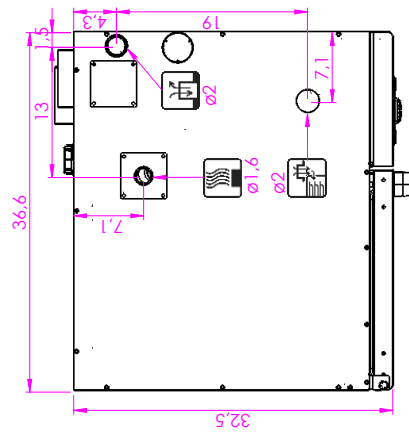
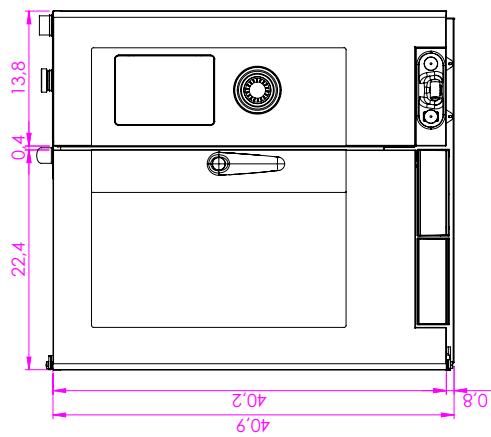

According to CE rules, gas ovens must be installed where proper evacuation of burnt gas can be provided (type B13, B23, A3)